

Chapter 3

Physical layer (3 courses)

The role of the physical layer is to transform a series of bits into signals (and vice versa) to adapt them to the communication channel and transmit them from one machine to another. The transformed bits represent digitized (encoded) information such as ASCII code for texts, avi for multimedia, etc.

The physical layer determines how bits are transported on the physical medium. It allows bits 0 and 1 to be introduced onto the medium in a specific form, recognizable by the receiver. Several components are used in this layer, such as modems, multiplexers, hubs, etc. This chapter studies transmission media and their characteristics as well as the methods used to transmit information on these media.

3.1 Transmission modes

Blocks of information transmitted over wires can be transmitted in parallel or in series.

3.1.1 Parallel transmission

In parallel transmission, bits of the same entity (byte, word, etc.) are sent on separate wires to arrive together at their destination. We can have 8, 16, 32 or 64 parallel wires.

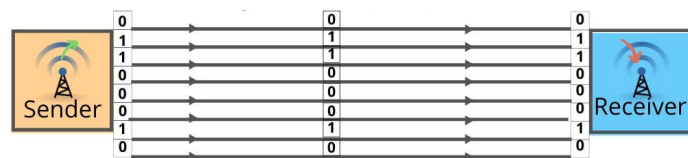

Parallel transmission poses synchronization problems because of possible phase shifts between the different wires. This is why this mode is only used over very short distances

such as a computer bus.

3.1.2 Serial transmission

In this transmission mode, the bits are transmitted one after the other. This is the mode used in computer networks, it can be asynchronous or synchronous.

3.1.2.1 Asynchronous transmission

The transmission can be carried out at any time, and does not depend on specific time intervals. The receiver begins reception on the arrival of a START bit and concludes reception on the arrival of a STOP bit

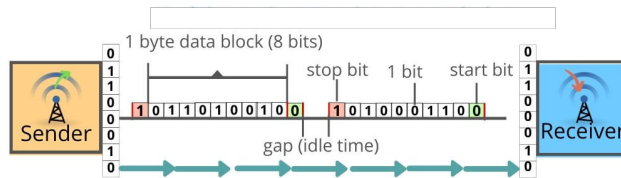

3.1.2.2 Synchronous transmission

In synchronous transmission, the transmitter and receiver agree on a constant elementary time interval which repeats constantly. The transmitter transmits at the start of the interval for a duration of one interval per piece of information (e.g.: 1 bit)

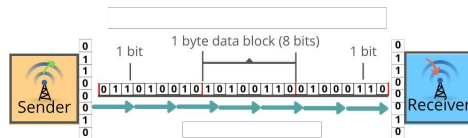

This mode is used for very high speeds

3.1.3 Simplex transmission

In certain cases of information exchange, one party is always the sender and the other is always the receiver. Data always flows in the same direction. The operation of the transmission channel is called in this case in simplex.



3.1.4 Half duplex transmission

In half-duplex transmission, the channel is used alternately for transmission: the two parties transmit both but not at the same time.

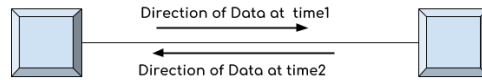

3.1.5 Full duplex transmission

Full-duplex transmission is simultaneous bidirectional. This is possible by sharing the bandwidth and assigning one part for one direction and the other for the other direction.

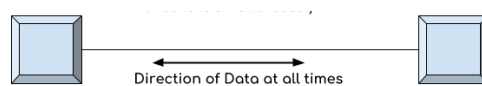

3.2 Signal transmitted

The signal is the vehicle of information between two devices. It propagates in a channel (link), material or immaterial in the form of an electromagnetic or light wave. The signal is a wave form resulting from the propagation of a vibration phenomenon. Depending on the physical quantity that is varied, three types of waves are used:

- electric waves (cables, wires, etc.),
- radio waves (radio beam, satellite),
- light waves (optical fibers, infrared).

In the simplest case a wave is expressed by a sinusoid:

$$y(t) = A \sin(2\pi ft + \varphi) ;$$

Where A is the amplitude, f the frequency and φ the phase.

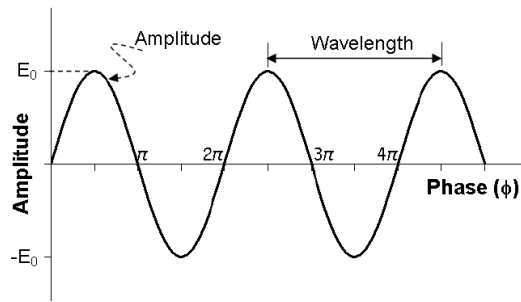

Signals can be in analog or digital form, analog signals are generally used for long distances, and digital signals for short distances.

3.2.1 Analog signal

An analog signal is characterized by a continuous variation, the value levels are proportional to the values of the information (sound, image).

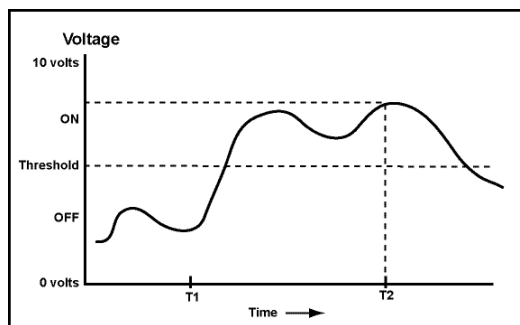

3.2.2 Digital signal

The digital signal is characterized by a square shape, a discontinuous variation and a small number of fixed value levels.

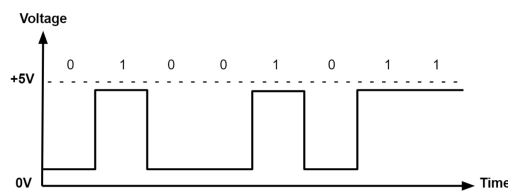

3.3 Characteristics of a communication line

Certain physical characteristics of media disrupt transmission. Knowledge of these characteristics (bandwidth, sensitivity to noise, limits of possible flow rates) is therefore

necessary to produce good signals, that is to say those best suited to the media used.

3.3.1 Bandwidth

The bandwidth of a channel is the frequency range over which the channel is capable of transmitting signals without their attenuation being too significant. It is defined by:

$$W = f_{max} - f_{min}$$

Where f_{min} is the lowest transmitted frequency and f_{max} is the highest.

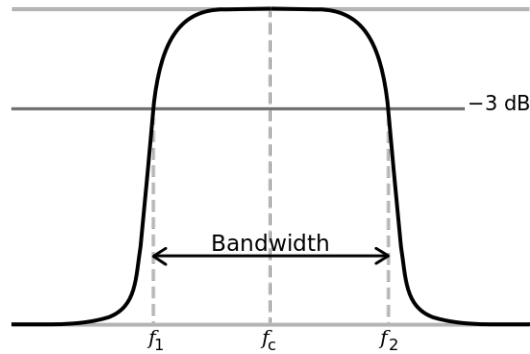

When we talk about bandwidth, we indicate an interval width without specifying the limits of this interval. For example, the bandwidth of the telephone line is 3100Hz.

3.3.2 Modulation speed

The modulation speed R , expressed in *bauds*, indicates the number of symbols transmitted per unit of time. If Δ represents the duration (in seconds) of the time interval separating two significant values of the signal, then:

$$R = \frac{1}{\Delta} \text{ bauds}$$

For a transmission medium, the maximum modulation speed depends on its bandwidth (Nyquist criterion). The maximum modulation rate R_{max} is equal to twice the highest frequency available on the medium:

$$R_{max} = 2F_{max}$$

3.3.3 Error rate

It represents the probability of loss or alteration of information (1 bit). It can be measured by calculating over a significant time the ratio of the number of erroneous bits to the number of bits transmitted.

3.3.4 Bit rate

The bit rate D is the number of bits transmitted per unit of time. For example 512 Kbits/s or 1 Gigabit/s.

The relationship linking the modulation speed to the bit rate is expressed by the formula:

$$D = R \times \log_2(V)$$

Where V designates the *valence* of the signal representing the number of significant states that the signal can take.

A valence of value V allows the transport of $P(\text{bits}) = \log_2(V)$ at each baud. For example, for simple modulations (valence 2 signals) each interval Δ carries 1 bit. The digital values of the bit rate and the modulation speed are then equal ($R = D$).

Exercise: If the duration of a bit is 20ms, what is the bit rate?

3.3.5 Propagation delay T_p

This is the time required for a signal to travel through a medium from one point to another. This time depends on the nature of the medium, the distance, the frequency of the signal, etc.

3.4 Transmission Media

Transmission media are numerous and are divided into two families: media with a physical guide and media without a physical guide. Physically guided media, such as twisted pair and coaxial cable, are the oldest, most widely used and used to transmit electrical currents. Glass or plastic media, such as optical fibers, transmit light, while media without a physical guide for wireless communications transmit electromagnetic waves and are booming.

3.4.1 Physical guide supports

These are media that use cables of different types to transmit information.

3.4.1.1 Twisted pairs

The twisted or wound pair consists of two identical twisted conductors. Winding reduces the consequences of parasites from the environment. The most common use of

twisted pair is the connection of users to the telephone exchange (RJ11 standard: Registered Jack). Local computer networks, where distances are limited to a few kilometers, use the RJ45 standard using cables containing 4 twisted pairs.

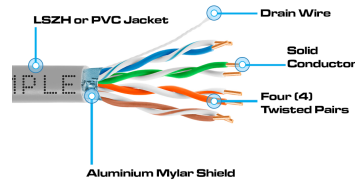

The connection of the RJ45 cables is done through the RJ45 connectors allowing the wires to be connected according to the following diagram:

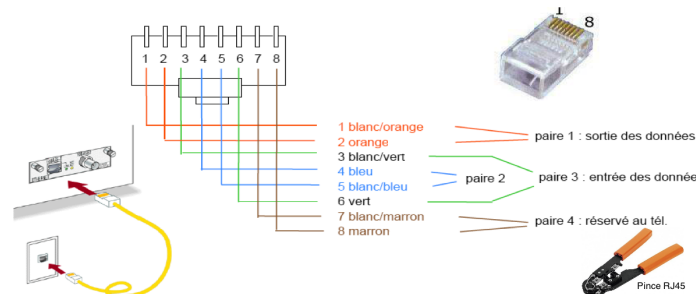

The manual manufacture of RJ45 cables is done using a special pliers called "RJ45 pliers".

The main disadvantage of twisted pairs is the weakening of transmitted currents. They often use, at regular intervals, elements called repeaters which regenerate the transmitted signals.

For enterprise LANs, twisted pair may be sufficient. Its advantages are numerous: mastered technique, ease of connection and adding new equipment, low cost and it can be used point-to-point or broadcast. There are generally three types of cables:

- UTP (Unshielded Twisted Pairs): unshielded and unscreened twisted pair cable. Sometimes used for telephony, not recommended for computing.
- FTP (Foiled Twisted Pairs): twisted pairs surrounded as a whole by an aluminum foil (screen). This is the standard type.
- STP (Shielded Twisted Pairs): twisted pairs each surrounded by aluminum foil.
- SFTP (Shielded Foiled Twisted Pairs) and SSTP (Shielded Shielded Twisted Pairs): shielded FTP or STP cables. For use in premises with strong electromagnetic disturbances.

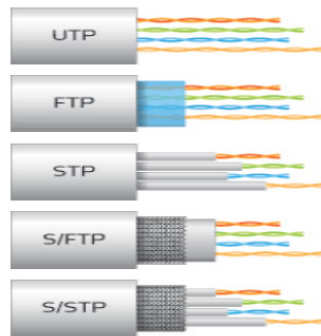

Twisted core cables are standardized in categories from Cat1 to Cat7. The most commonly used currently are:

- Category 3: 16MHz bandwidth, used for telephony.
- Category 5: Bandwidth 100MHz, Speed 100MB/s over 100m used for telephony and networks
- Category 6: 250MHz bandwidth, GB/s speed over 100m used for networks
- Category 6a: Bandwidth 500MHz, Speed 10GB/s over 100m
- Category 7: Bandwidth 600Mhz, Speed 10GB/s

3.4.1.2 Coaxial cable

The coaxial cable is made up of two cylindrical conductors with the same axis separated by an insulator, the whole being protected by a plastic sheath.

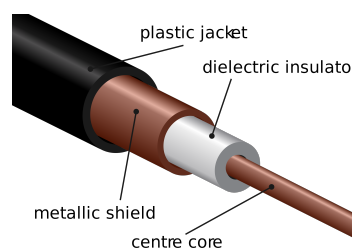

There are two types of coaxial cable:

- The 75Ω cable, called "broadband" used for analog transmission: it's the television cable!
- the 50Ω cable, known as "baseband" generally used to transmit digital signals. It allows a bandwidth of a few hundred MHz and speeds of up to 2Gbit/s.

The coaxial cable is connected by vampire plugs for large cables and BNC (British Naval Connector) plugs for thin cables.

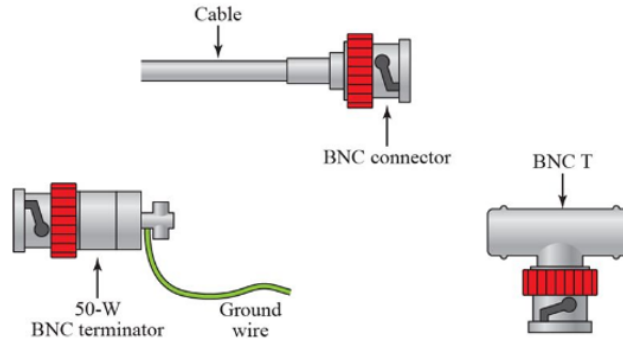

Coaxial cable has better transmission quality and speeds than twisted pairs and can be used point-to-point or broadcast. However, it is a little more expensive.

3.4.1.3 Optical fiber

An optical fiber is made of a very fine glass wire. It includes a core, in which the light emitted by a light-emitting diode or a laser source propagates, and an optical cladding whose refractive index guarantees that the light signal remains in the fiber.

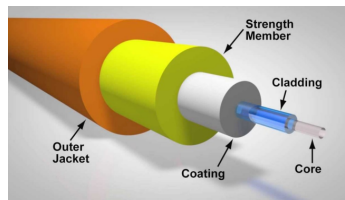

An optical fiber transmission system implements:

- a light emitter (transmitter), consisting of a light emitting diode (LED, Light Emitting Diode) or a LASER diode (Light Amplification by Stimulated Emission of Radiation), which transforms electrical pulses into light pulses;
- a light receiver, consisting of a PIN (Positive Intrinsic Negative) type photodiode which translates light pulses into electrical signals;
- an optical fiber.

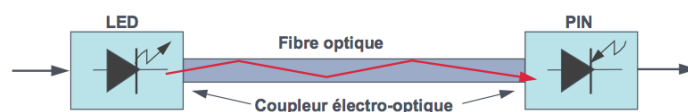

Fiber being a unidirectional transmission system, an optical link requires the use of 2 fibers.

There are three types of optical fiber.

1. Index-jumping multimode fiber: the core with refractive index n_1 is surrounded by a cladding with index n_2 . The variation in index between the core and the sheath is sudden (jump in index). Propagation takes place by total reflection at the core/sheath interface. The diameter of the core is large, which allows it to admit several rays which propagate on different paths or modes of propagation. The range of the rays is 10 km.
2. Multimode fiber with index gradient: in this type, the core index decreases continuously, from the center of the core to the core/sheath interface following a law parabolic. All the rays are focused at the center of the fiber, they have a trajectory close to the sinusoid. The dispersion is reduced, which allows ranges of around 50 km.
3. Single-mode fiber: the core diameter is reduced to $8 \mu m$. This reduction can be such that, for a given wavelength, the fiber only admits a single ray. The fiber is then called single-mode and the spanable distance is of the order of 100 km.

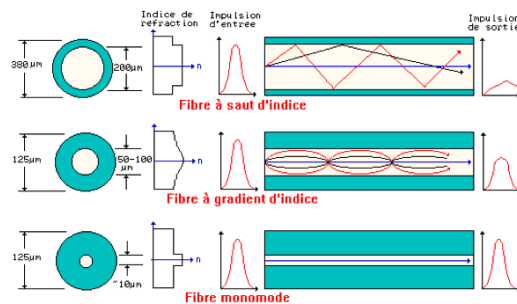

The optical fiber connection uses SC (Subscriber Connector), ST (Straight Tip), FC (Fiber Connector), LC (Lucent Connector) type connectors.



Although optical fiber only allows point-to-point connections, its advantages are numerous:

- Speeds of up to 50 GBit/s (theoretical speed 50 TBit/s),
- Simultaneous transmission of numerous television, telephone, etc. channels
- Insensitive to electromagnetic interference,
- External diameter is of the order of 0.1 mm,
- Weight of a few grams per kilometer.
- Difficult to hack.

3.4.2 Supports without physical guide

Media without a physical guide transmit electromagnetic waves or light.

3.4.2.1 Electromagnetic waves

Electromagnetic waves propagate through the atmosphere. The absence of hardware support provides a certain flexibility and is suitable for applications such as telephony or mobile telecommunications, without requiring costly cable laying.

A transmitting antenna radiates energy (electromagnetic wave). This electromagnetic energy collected by another remote conductor or receiving antenna is transformed into an electric current similar to that of excitation of the transmitting antenna.

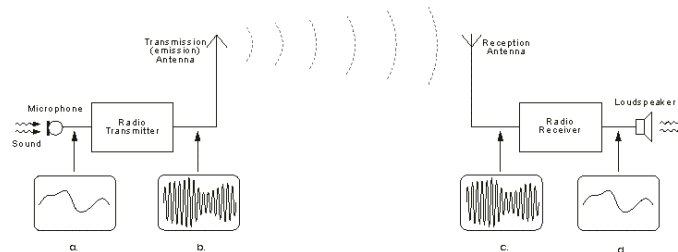
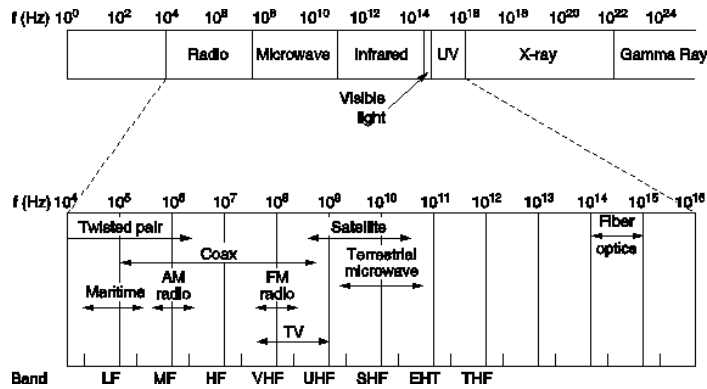

Fig. 2.1. Radio Transmission Block-Diagram

Each type of link or application uses different frequency bands. The usable frequency space is limited and managed by national and international organizations. The following figure describes the use of the different frequency ranges.



High frequencies (radio beams) are used to bridge large distances while low frequencies (radio waves) are used to reach geographically dispersed receivers.

3.4.2.1.1 Ray beams Radio relays are based on the use of very high frequencies (from 2 GHz to 15 GHz and up to 40 GHz) and directional beams produced by directional antennas which transmit in a given direction. Wave propagation is limited to the optical horizon; transmission takes place between stations placed at height, for example on a tower or at the top of a hill, to avoid obstacles due to surrounding constructions. Radio links are used for satellite transmission, for television channels or to constitute long-distance transmission arteries in telephone networks.

3.4.2.1.2 Radio waves Radio waves correspond to frequencies between 10 kHz and 2 GHz. A transmitter broadcasts these waves picked up by geographically dispersed receivers. Unlike radio relays, it is not necessary to have direct visibility eour transmitter and receiver, because the latter uses all of the reflected and diffracted waves. On the other hand, the quality of the transmission is lower because the interference is numerous and the transmission power is much lower.

3.4.2.2 Light waves

Infrared and laser links constitute a special case of radio links. They are generally used to interconnect two private networks, over short distances, of the order of a few hundred meters. They use technologies comparable to those of optical fibers, but instead of taking a glass channel, the data travels through the air at very high speeds that can exceed 1 GBit/s. The signal is digitized and transmitted by an infrared or laser beam in a precise line of sight. Most often, these connections are made between transmitters installed on top of buildings and communicating point-to-point via beams.

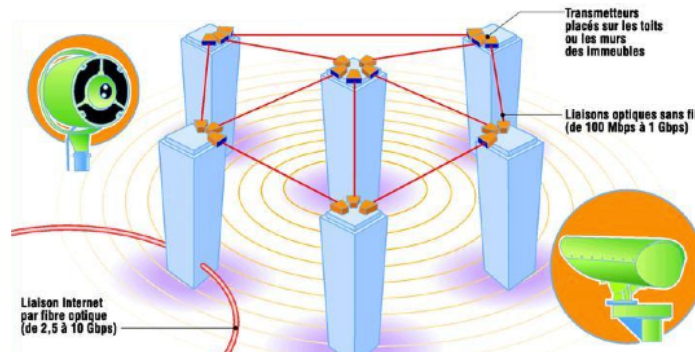

3.5 Information coding

To transmit the data, specific equipment is placed at each end of the support: either a modem (modulator-demodulator) or a codec (encoder-decoder). This equipment ensures the production of signals in transmission and their recovery in reception. To transmit the data, the modem receives the sequence of binary data to be transmitted and provides a signal whose characteristics are adapted to the transmission medium. Conversely, on reception, the modem extracts the sequence of binary data from the received signal. The transmission medium is thus transparent to the user. The transmission medium and the two modems placed at each of its ends constitute a set called a data circuit.

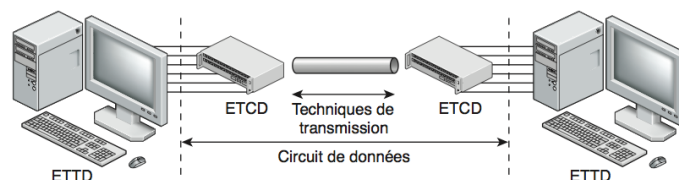

The ISO and the ITU (International Telecommunications Union) have assigned standardized generic names to the different elements of this system. So the modem and codec are called DCE (data circuit terminating equipment) and the computer is called DTE (data processing terminal equipment).

The transmitting DTE provides the DCE, regularly over time, with the data to be transmitted. The DCE transmits them as a two-value signal (corresponding to 0 and 1), called a synchronous data message.

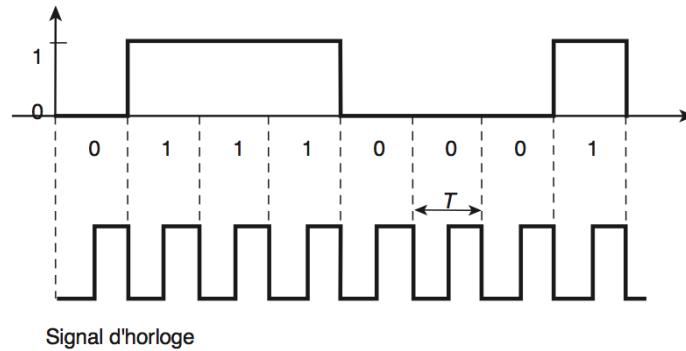

The time intervals allocated to each symbol are equal and coincide with the successive periods of a time base (or clock) essential for the interpretation of the data message.

If the distance between the two DCEs allows it, the digital signal is transmitted directly, the transmission is called in this case *base band*, that is to say in the same band of the original signal. Otherwise, the signal is modulated and the transmission is called *wideband* or *transposed band*.

3.5.1 Digital transmission (baseband)

When the length of the link does not exceed a few hundred meters, the information can be transmitted on the link medium without transforming the digital signal into an analog signal.

Baseband transmission, encountered mainly in local networks, makes it possible to obtain high-speed, short-range data circuits (rates greater than 1 Mbit/s for distances less than 1 km) by directly using physical media of the type metallic (twisted pairs or coaxial cable) or optical with possibly the addition of repeaters arranged at intervals ranging from 500 meters to a few kilometers.

Transmitting long sequences of 0s or 1s (silences) can make it difficult to recover the clock, consequently causing loss of synchronization between the transmitter and receiver. Several types of coding are used to introduce frequent state changes to the signal to avoid silences.

3.5.1.1 Unipolar coding

The signal is transmitted without the slightest change.

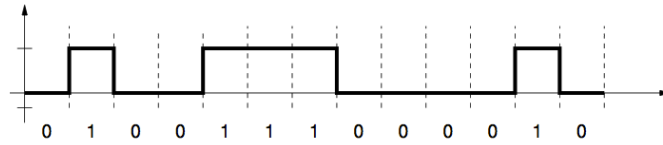

The problem with this coding is that it does not make it possible to distinguish the case of 0 from the case of absence of information.

3.5.1.2 NRZ encoding

To avoid zero, NRZ(No return to zero) encoding uses a $+a$ value of the signal to represent a 1 and $-a$ for a 0.

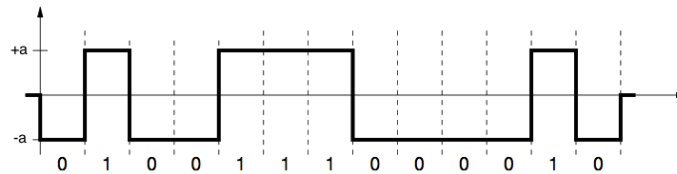

3.5.1.3 NRZI coding

The NRZI (No Return to Zero Inverted) code has the same characteristics but to avoid successions of 0s, the signal remains in the same state to encode a 1 and changes state to encode a 0.

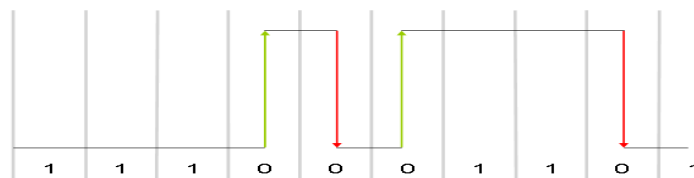

3.5.1.4 Biphas code or Manchester code

An XOR (exclusive OR) operation is performed between the clock and the data, resulting in a systematic transition in the middle of each bit of the binary signal.

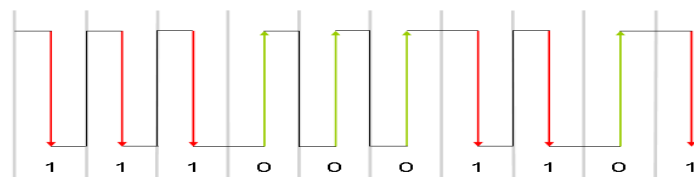

3.5.1.5 Differential Manchester code

A systematic transition is made in the middle of each bit. No transition to encode a bit to 1, one transition to encode a bit to 0

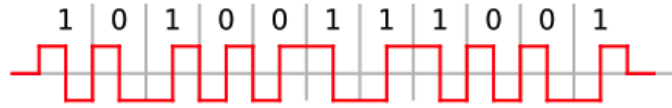

3.5.1.6 Miller code

A mid-bit transition for a 1, no mid-bit transition for a 0. A transition at the end of the bit for a 0 if the next bit is also a 0.

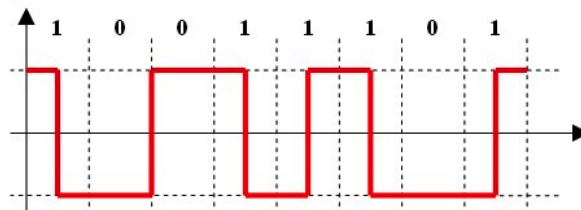

3.5.2 Modulation (wideband)

Baseband techniques are unreliable once the distance exceeds a few hundred meters. To have a signal that can be recovered correctly, it must be given a special shape (sinusoidal) by modulating it. Transmission by modulation consists of sending a sinusoidal wave called a carrier. The fact of no longer having rising or falling edges protects the signal much better from degradation caused by the distance traveled by the signal in the cable since the signal is continuous and no longer discrete. The transmission modulation and reception demodulation operations are carried out by the DCE commonly called a modem (modulator-demodulator).

Depending on the data to be transmitted, the modem modifies one of the carrier parameters (frequency, phase or amplitude). We distinguish the following three main categories of modulation:

- amplitude modulation, or ASK (Amplitude-Shift Keying);
- phase modulation, or PSK (Phase-Shift Keying);
- frequency modulation, or FSK (Frequency Shift Keying).

We often use combined modulations of the three previous types.

3.5.2.1 ASK (Amplitude-Shift Keying)

In amplitude modulation, the distinction between 0 and 1 is obtained by a difference in signal amplitude.

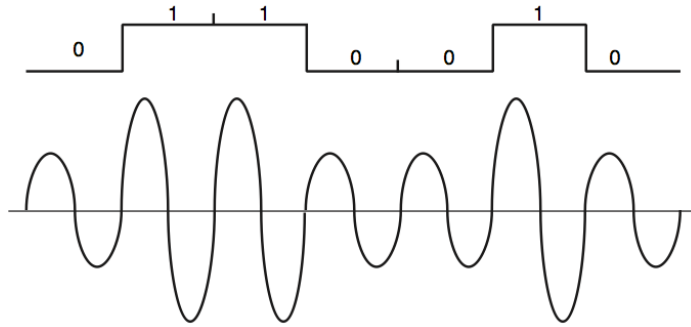

3.5.2.2 PSK (Phase-Shift Keying)

For phase modulation, the distinction between 0 and 1 is made by a signal that starts at different locations on the sinusoid, called phases.

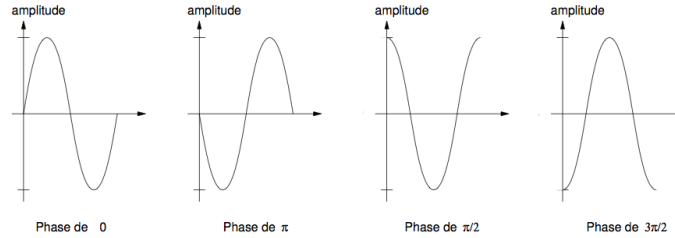

In the following figure, the values 0 and 1 are represented by respective phases of 0 and π .

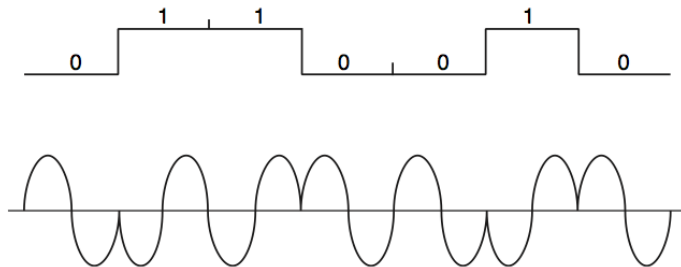

3.5.2.3 FSK (Frequency Shift Keying)

In frequency modulation, the transmitter has the possibility of modifying the frequency at which the signals are sent depending on whether the binary element to be transmitted is 0 or 1.

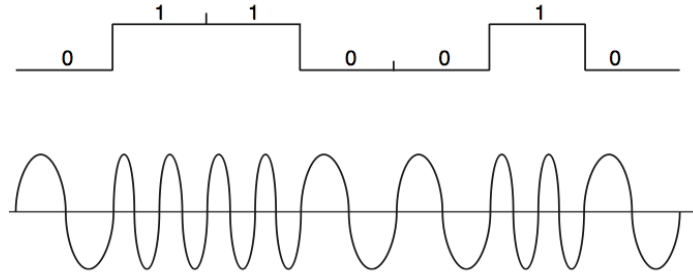

3.5.2.4 Phase and amplitude modulation (PSK + AM)

To obtain even higher transmission speeds in PSK type modulation, it is necessary to multiply the number of phase states (commonly 4, 8, 16 states or more). By combining phase modulation with amplitude modulation, we obtain a better distribution of points on the spatial diagram and therefore better noise immunity. For example, in the following figure, we combine 2 phases and 2 amplitudes:

- 00: phase of π and amplitude of 3
- 01: phase of π and amplitude of 6
- 10: phase of 0 and amplitude of 3
- 11: phase of 0 and amplitude of 6

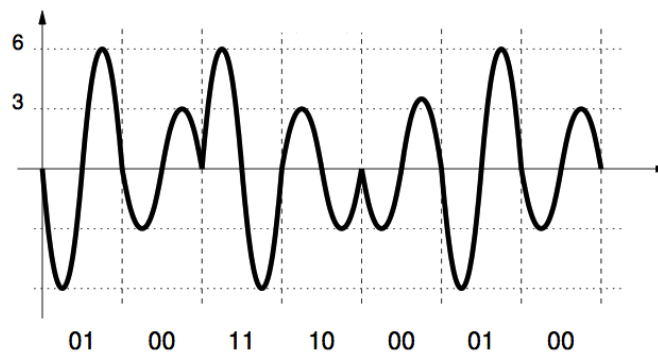

3.5.2.5 ADSL transmission

The capacity of twisted pair telephone lines is limited on the one hand by the bandwidth, and on the other hand, by the signal-to-noise ratio. However, over distances limited to a few kilometers, by improving the signal/noise ratio, it is possible to exceed the speeds of a few tens of kbit/s obtained with modulations. previous ones.

The technique used in the Asymmetric Digital Subscriber Line makes it possible to achieve speeds of several Mbit/s over distances of less than 5 km. This solution is implemented to allow, among other things, subscribers of the PSTN (fixed) switched telephone network to access the Internet at high speeds. It also makes it possible to ensure telephone communication simultaneously with data transfers.

Taking into account the objectives, the flow rates in the subscriber-to-network direction (upstream or upstream flow) are lower than in the network-to-subscriber direction (downstream or downstream flow).

Typical throughput values are 640 kbit/s and 2 Mbit/s for upstream and downstream streams respectively, which corresponds to queries on servers or databases. To obtain such speeds, the frequency band used on telephone pairs goes from 0 Hz to 1.1 MHz (for lines supporting such frequencies over short distances). The 0 Hz to 4 kHz band is reserved for analog voice communications. The 64 kHz to 1.1 MHz band is used for data transmission in two separate bands, one for each stream.

The connection, at the network and subscriber level, is done according to the following diagram:

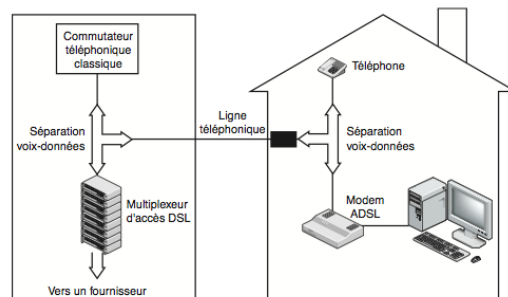

3.6 Multiplexing

Multiplexing consists of passing communications belonging to several pairs of transmitter and receiver equipment over a single connection line, called a high-speed channel. Each transmitter (receiver) is connected to a multiplexer (demultiplexer) by a so-called

low-speed channel link.

Several techniques are possible:

3.6.1 TDMA (Time Division Multiplexing Access)

It shares the use of the high-speed channel over time by successively assigning it to the different low-speed channels even if they have nothing to emit. Depending on the techniques, each time interval allocated to a channel will allow it to transmit 1 or more bits.

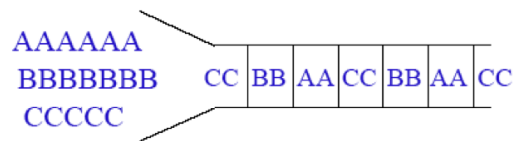

3.6.2 Frequency Division Multiplexing (FDM)

It consists of assigning to each low-speed channel a particular bandwidth on the high-speed channel while ensuring that no low-speed channel bandwidth overlaps. The multiplexer takes each signal from the low speed channel and puts it back on the high speed channel within the intended frequency range. Thus, several transmissions can be made simultaneously, each on a particular frequency band, and on arrival the demultiplexer is capable of discriminating each signal on the high speed channel to direct it to the correct low speed channel.

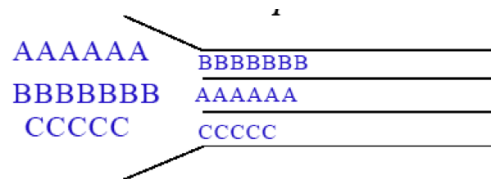

3.6.3 ATDM (Asynchronous Time Division Multiplexing) statistical multiplexing

It improves time multiplexing by only assigning the high speed channel to the low speed channels that actually have something to transmit. By not transmitting the silences of the lower channels, this technique implemented in concentrators greatly improves the overall transmission rate but it uses higher level protocols and is based on statistical averages of the rates of each low speed line.